

- Complete system, supplied with rods and guides
- Assembled and 'handed' on site
- Stainless steel or zinc-plated

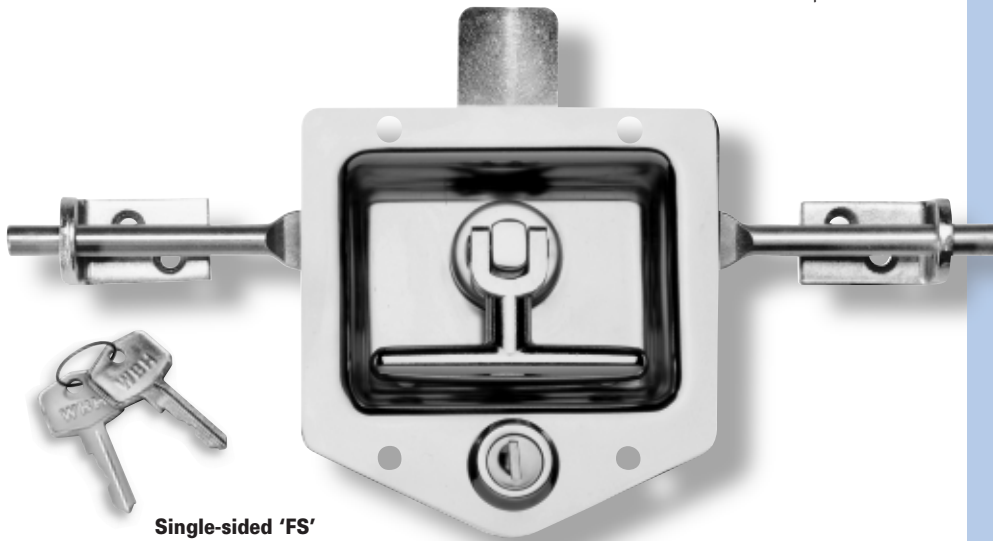

Single-sided 'FS' keys as standard

ORDERING CODE

- 9/01561** 3-way Drop-T set, stainless, mixed differ, c/w rods
-
- 9/01561/01** As 9/01561, FS880
-
- 9/01562** 3-way Drop-T set, mild steel, mixed differ, c/w rods
-
- 9/01562/01** As 9/01562, FS880
-
- 9/01567** Centre only, 3-way Drop-T, stainless
-
- 9/01567/01** As 9/01567, FS880
-
- 9/01568** Centre only, 3-way Drop-T, mild steel
-
- 9/01568/01** As 9/01568, FS880

Non-Locking models shown opposite

Direction of Movement

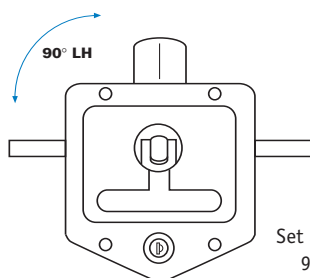

Set at factory for 90° LH but 'stops' are reversible on site

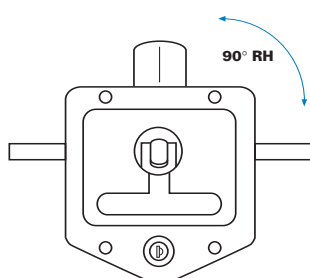

SPECIFICATION

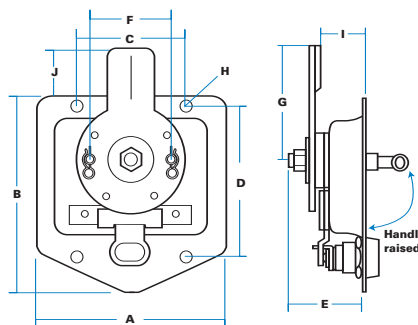

| | |
|---------------------------------------|---------------|
| A Width of pan | 120 mm |
| B Length of pan | 125 mm |
| C Hole centres | 69 mm |
| D Hole centres | 95 mm |
| E Max depth | 45 mm |
| F Rod fixing centre | 52 mm |
| G Length of latch Cam depth | 70 mm 3 mm |
| H Hole sizes (dia) | 7.5 mm |
| I Engagement | 27 mm |
| J Visible length | 30 mm |

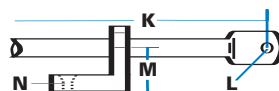

| | |
|---------------------------------|---------------------|
| K Rod length | 1145 x 9.5 mm |
| L Hole dimension | (dia) 7.5 mm |
| M height to central line | 14 mm |
| N Hole sizes | (dia) 5mm c/s 10 mm |









Rods withdraw by 25mm in line of travel, as latch disc rotates through 90°.

Rod Ref (3/18702) Guides Ref (3/18716)

222

'DROP-T' 3-WAY LATCH SYSTEM

The 3-way 'Drop-T' provides a complete latching system for the largest doors. Handle, lock, latch and flush recess pan form a self contained unit needing only a simple cut-out. Rods attached on site and adjustable for either LH or RH movement. Suits drop-down hatches, truck toolboxes and other large enclosures.

-  Polished diecast 'hub', and neoprene seal under stainless 'cup' washer for good appearance, corrosion-resistance and weatherproofing.
-  Lift handle to turn, releasing latch tongue and withdrawing rods. Reverse to close. Tongue has 3mm cam-form for easy engagement.
-  Latch travels 90° from centre against 'stops', which can be adjusted to allow either LH or RH operation.
-  Four holes in flanges at 7.5mm diameter. Rods are secured by split pins through pillar rivets.
-  'FS' keys as standard, with shuttered keyway. Optionally 'FT', '92' or 'DLP' keys.
-  Polished stainless steel with chrome handle and hub, or mild steel, zinc-plated. Optionally, black powder-coated.
-  'T' pan in 2mm stainless steel, Grade 304, bright polished, or mild steel to CR4, zinc-plated. 'T' handle and hub are zinc diecast, polished and chromium-plated or zinc-plated.
-  Special rod lengths. Plain flanges or 'blind-mounting' with M6 welded studs. Non-locking and 2-way models, cranked tongues, etc. Weathershield options.